

orlański



natural warmth of the house

INSTRUCTION MANUAL & SERVICE MANUAL ORLAN SUPER 18-80 kW



Orland

ISO 14001 ISO 9001 CE

Contents

1. Boiler's use.....	3
2. Procedure rule.....	4
3. Installation	4
3.1. Diagram of chimney choice according to the DIN 4705 4 norm.....	5
4. Description of CONTROL SYSTEM.....	6
4.1. Front panel of EKOSTER 2 regulator.....	6
4.2. Technical data of EKOSTER2 regulator - type 3.1	6
4.3. Functions of EKOSTER 2 regulator	7
5. Technical data of a boiler.....	11
6. Connecting and exploitation	13
6.1. Connecting.....	13
6.2. Wood and gasification	14
6.3. Accumulation	15
6.4. Starting.....	16
6.5. Burning up	16
6.6. Fuel loading.....	16
6.7. Boiler's putting out.....	17
6.8. Right boiler's temperature assuring	17
6.9. Power failure and pump's breakdown.....	17
7. Conservation	18
7.1. Boiler's conservation	18
7.2. Fan's conservation	18
7.3. Boiler's cleaning.....	18
7.4. Leakproof securing.....	19
7.5. After-heating season maintenance activities	20
8. Faults caused by boiler's wrong exploitation and their removing	21
9. Allowance for Orlan SUPER boilers.....	22
9.1. Cooling coil.....	22
9.2. Cleaning devices mechanism	22
10. Utilizing	23

1. Boiler's use

Orlanski's gasification boiler ORLAN SUPER is designed to work with solid fuel like: logs of wood with dimensions of the boiler chamber, wood dust, wood chips and waste forestry. Logs of wood must have moisture content between 15-25% and max. length 5 cm shorter than loading chamber depth depending on boiler size; wood log diameter should be 15-25 cm.



NOTICE!

Using different than ordinary fuel doesn't guarantee boiler's right operating - as it was featured in technical data and it can influence the boiler's way of working and its long-lasting.



NOTICE!

Using different type of fuel that the main one is treated as wrong boiler's using and its effects can not be the reason for any complaint to the producer.



NOTICE!

Wood boiler is equipped with a regulator which assures its working in right temperature's range and protects the boiler against its overheating by fan's turning on.

2. Procedure rule

Wood gasification boilers work in pirolitic wood distillation process. When the air is limited wood changes into charcoal while burning up. In the same time wood gas appears, which next relocates to burner's nozzle and there it is burnt at the bottom of the boiler. Such method of wood burning allows for its effective using as fuel. Orlan boilers are made for burning wood billets (use minced wood only as an addition - it should be mixed with bigger wood parts as not to allow for burner's nozzle littering).

3. Installation

Wood boilers are to be installed according to the present norms and rules. The requirements of norm PN 87/B 02411 according building of solid fuel boiler room and the norm PN 91/B 02414 according closed system boilers' installation should be taken into account. These norms and rules should be followed, however, caution is required as national rules in countries in which the product is sold may replace above-mentioned norms.

In case of boiler assembly outside the Poland, rules and norms should be followed according to solid fuel boiler assembly in countries in which the product is sold. Eko-Vimar Orlanski wood gasification boilers type SUPER are adjusted for installation in closed systems.

Eko-Vimar Orlański company prescribes using chimney inputs which preserve against the chimney permeating. The company doesn't take responsibility in case of faults resulting from not using chimney inputs.

1. Chimney flue should correspond to the parameters of „DIAGRAM OF CHIMNEY CHOOSING ACCORDING TO THE DIN 4705 NORM”.
2. Boiler room should be large enough to enable boiler's cleaning (>2,2 m).
3. The distance between the boiler and the partitions should enable right access for all of the boiler's parts - it shouldn't be less than - look at "Orlan boiler placing".
4. There shouldn't be any cables nor electric installations which aren't for boiler room using.

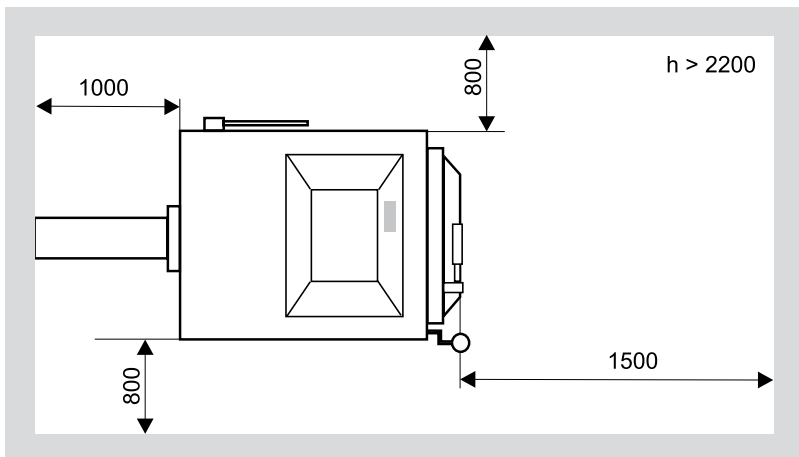

Pic.1 Orlan boiler placing.

Chimney sweep should approve smoke outlet before its connecting to a chimney flue.

According to the PN-EN 303-5 norm accumulation tank should be assembled together with wood boiler. We choose about 55 l heating water for every 1 kW installed power for example Orlan 25 kW = 25 kW x 55l = 1375 l



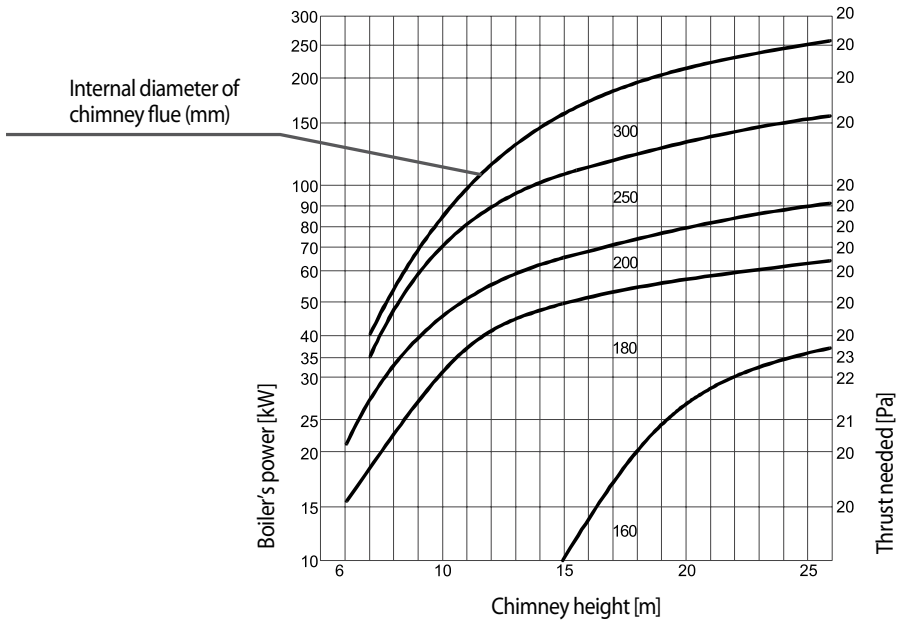



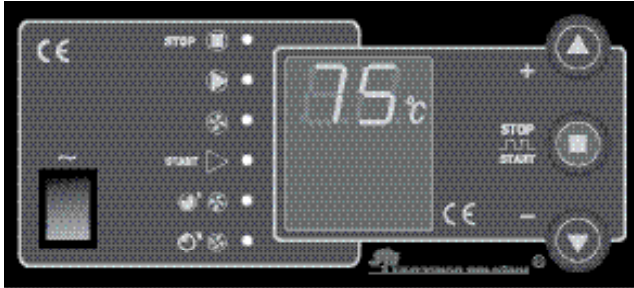

3.1. Diagram of chimney choice according to DIN 4705 norm



4. Description of CONTROL SYSTEM

4.1. Front panel of EKOSTER 2 regulator



- STOP  STOP
-  PUMP'S OPERATION
-  FAN'S OPERATION
- START  FIRING-UP MODE
-   BLOW-THROUGH - INTERNAL TIME
-   BLOW-THROUGH - OPERATING TIME
-  POWER SWITCH

Pic.2 Description of the regulator's panel.

4.2. Technical data of EKOSTER2 regulator - type 3.1

1. Temperature range	-9 °C up to +99 °C	
2. Temperature setting	+60 °C up to +80 °C (in the type 3.4: +60 °C up to +97 °C)	
3. Temperature of the pump turning on	+65 °C (in the type 3.4: +65 °C up to +90 °C)	
4. Blowdown regulation	working time	0-90 seconds
	stopover	1-15 minutes
	possibility of full blow-through turning off	P-0
5. Hysteresis (the difference turn on- turn off)	From 2 up to 9 °C	
6. Maximum switching power	fan	100 W
	pump	100 W
7. Main supply voltage / Frequency	230 V AC, 50 Hz	
8. Maximum power taking	275 VA	
9. Fan regulating power in % x 10	(regulation range from 30-100 %)	
10. Outside humidity	≤ 95 %	
11. Protection rating	IP 40	

12. Insulation class	I
13. Surrounding temperature	0 – 40 °C
14. Disconnecting type	full
15. Over current protection	2 x 1.25 A (fuse)



NOTICE!

If the “Er” appears on the screen it means that temperature either raised over 99 °C, it decreased below -9 °C or the sensor got damaged. To secure together the boiler and installation up to the time of the sensor replacing pump should be continuously ON till that time.

4.3. The functions of EKOSTER 2 regulator



Use



The microprocessor temperature regulator for central heating boiler is designed to control the air blow in wood-fired boiler and to actuate circulating pump in central heating system

The regulator performs the following functions:





- maintaining the set temperature of boiler by controlling air blow,
- smooths start-up of a blower,
- setting the blower power (service mode),
- programmable boiler „blow-through”,
- automatic control switch-off after boiler burnout (extinguishes),
- blower interlocking when feeding the boiler,
- control of central heating circulating pump depending on its set operating temperature,
- „COMFORT SYSTEM”,
- protection against freezing or overheating of boiler,
- signalling of temperature sensor’s damage,
- regulating the brightness of display - increased during read out and change of regulator settings,
- control panel connecting possibility,
- room thermostat cooperation,
- automatic turning off in case of wrong burning up in the boiler,
- EKOSTER CONTROL cooperation.

Regulator working description

After switching on, the regulator passes into **STOP**  state signalled by switching on of corresponding lamp. Operation commences after pressing **START**  button or automatically when boiler’s temperature rises above operating threshold - that is, difference between set boiler temperature and factory-set temperature difference “dt”. Automatic transition into **STOP**  state occurs 30 minutes after boiler temperature drops below operating threshold. CONTROL receptacle is for connecting remote control.

Pushbuttons  and  serve to change the settings. During normal operation, pressing them causes display and change of set boiler temperature. Pressing and holding pressed causes increase in speed of temperature setting change.



Pressing the **START**  button causes:

- with temperature below operating threshold: switching on or switching off control, signalled by **START**  or **STOP**  indicators respectively,
- with temperature above operating threshold: blower interlocking signalled by pulsation of **STOP**  indicator, enabling feeding of fuel into the boiler. Automatic return to operation **START**  pressing.









COMFORT SYSTEM facility

The COMFORT SYSTEM function built into the regulator prevents against stone deposition between pump rotor and stator. The regulator automatically actuates the pump after the heating season for about 30 seconds, every 14 days. Operation of the pump in this mode is signalled by pulsation of PUMP  indicator. The system begins to operate 1 minute after regulator's switching on. Actuation of the pump in automatic mode causes re-counting of the 14-day period from the beginning.

Antifreeze and overheating protection system

When the temperature decreases below 4 °C regulator secures the installation against its freezing by the pump's turning on. Temperature's rising to more than 90 °C (in the type 3.4: +97 °C) causes the fan's turning off and the pump's turning on. The button **STOP**  beating alarms of the boiler's overheating. In the case reasons for overheating should be found, eliminated and as it follows boiler should be engaged again by the button **START**  pressing. Pump is continuously on in case of the temperature's sensor breaking down.

Programming of blow-through

- Press **START**  and hold for about 3 s until the OPERATING TIME   indicator switches on,
- set the blow-through time in seconds with pushbuttons , ,
- Press **START** ,
- set the blow-through interval in minutes with pushbuttons , ,
- Press **START** .

If the temperature exceeds over the set one, regulator will turn the fan ON from time to time.



NOTE!

- **setting the blow-through time to „0” causes blow-through switching off,**
- **above temperature of 85 °C (in the type 3.4: +98 °C), blow-through is switched off to prevent overheating of the boiler.**



Remote control

Regulator is accommodated for the remote „EKOSTER CONTROL” connecting, which enables to control and change current boiler's temperature, preview of the pump connection and START-STOP mode, in the same time sonic gauge alarms when the boiler's temperature abruptly increases to hazardous level. Remote control with 10 m wire doesn't go as a standard set - they are to be bought separately.

Service mode

It is for regulator's settings changes. To work on the mode you should:

- Switch off the power,
- Switch the power back and in the time of some regulator's version displaying (for example 2.2) press the **START**  button and hold it up to the moment of "HI" appearing on the screen. Since the time screen alternately shows the symbol and value of regulation task.

With ,  buttons the value can be changed and **START**  button causes moving to the next regulation settings.



NOTICE!

Pump live wires' connections and fuse's replacement should be made when the regulator is OFF (connecting plug should be taken out of the current slot). If the condition is not made it may cause electric shock.

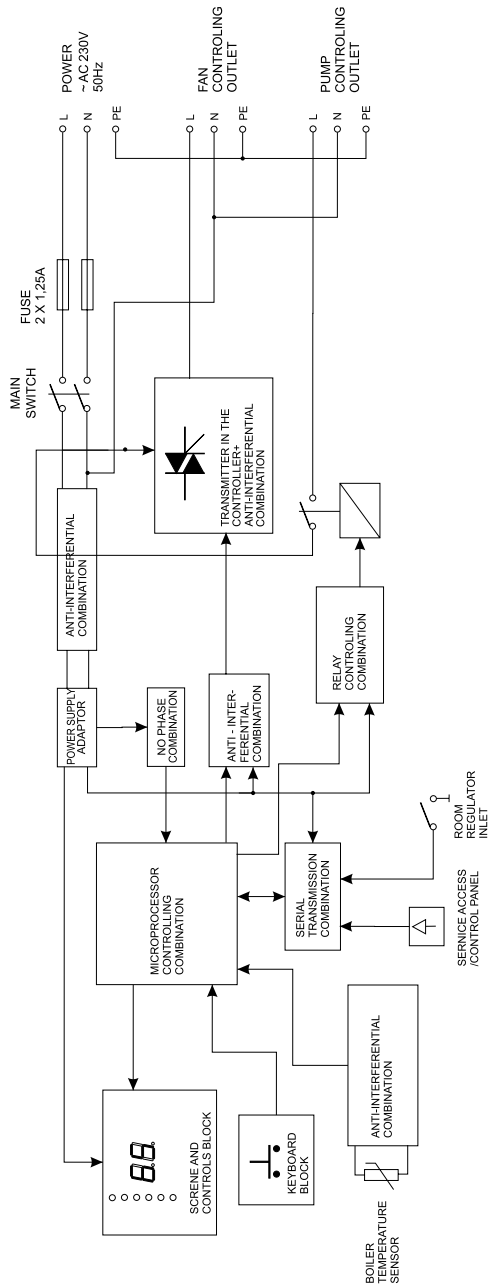

Pic.4 Regulator operation and wiring system scheme.

5. Technical data of a boiler

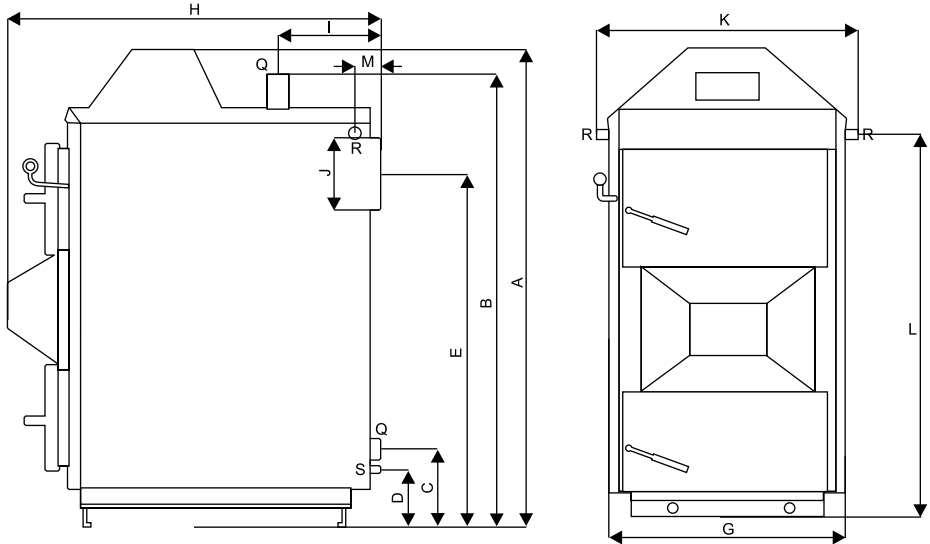

Main construction parameters' listing

Power	kW	19	25	40	60	80
Total height	A - mm	1220	1320	1570	1540	1540
Heating water outlet height	B - mm	1210	1300	1560	1575	1590
Heating water inlet height	C - mm	210	230	220	200	200
Bleeder height	D - mm	140	140	140	140	140
Chimney height	E - mm	870	960	1210	1160	1170
Width of a casing	G - mm	545	600	600	740	740
Total length	H - mm	960	1040	1040	1340	1700
Heating water outlet	I - mm	340	310	300	570	600
Chimney diameter	J - mm	180	200	200	210	210
Total width	K - mm	660	720	720	860	860
Cooling coil connection height	L - mm	990	1100	1330	1310	1300
Cooling coil outlet	M - mm	260	270	260	370	330
Diameter of a flange	Q - cale	2"	2"	2"	2"	2"
Cooling coil flange diameter	R - cale	3/4"	3/4"	3/4"	3/4"	3/4"
Blowdown connection diameter	S - cale	1/2"	1/2"	1/2"	1/2"	1/2"

Main construction parameters' listing

Power	kW	19	25	40	60	80
Power range	kW	7-19	10-25	16-40	24-60	32-80
Efficiency	%	91				
Boiler class		3	5	5	3	3
Boiler weight						
Water capacity	dm ³	55	75	93	180	205
	l	55	75	93	180	205
Loading/combustion chamber capacity	dm ³	85	120	185	310	465
	l	85	120	185	310	465
Charging hole Width/Length	mm	225/380	260/432	260/432	285/580	285/580
Fuel combustion time	h	7-12				
Billets' length	cm	50	50	50	75	100
Wood humidity	- recommended	%				
Power range for every kind of fuel:		15-25				
Billets	kW	7-19	10-25	16-40	24-60	32-80
Fuel taking for power:						
- nominal	kg/h	6,8	8,2	10,1	15,1	19,8
- minimal		3,9	5,7	7,9	11,9	15,8
Max. working pressure	bar	3				
Min. return temperature	°C	60				
Hydraulic resistance (primary cycle)						
- t = 20 K	mbar	1,2	1,4	1,6	1,7	1,6
- t = 10 K	mbar	4,0	4,3	4,9	4,9	4,8
Temperature regulator setting range	°C	60-97				
Electric protection range		IP 40				
Pressure/Frequency	V/Hz	230/50				
Auxiliary power	W	50	50	50	100	100
Fumes features (at nominal power):						
- fumes temperature	°C	150-180	150-180	150-180	150-180	150-180
- fumes flow	kg/s	0,0066	0,0088	0,0144	0,0216	0,0272
Chimney draught required	mbar Pa	0,15-0,20 15-20				
Cooling water pressure required at the influx to a heat exchanger	bar	2				
Cold water temperature in the heat exchanger	°C	10				
Advisable capacity of an accumulation tank	l	750-1500	1000-2000	2000-3000	3000-4000	4000-5000

6. Connecting and exploitation

6.1. Connecting

Four-way mixing valve is essential for any installation. Its role is to mix hot water (contribution water) with the one returning from the system. Water mixing is necessary as to avoid „cold return of the water” and to keep the same temperature of the boiler. What follows the temperature of heating system’s feeding can be lowered to the temperature of satisfactory warmth in the house. Mixing valves should be used both in gravity system and with extorted flow (pump).

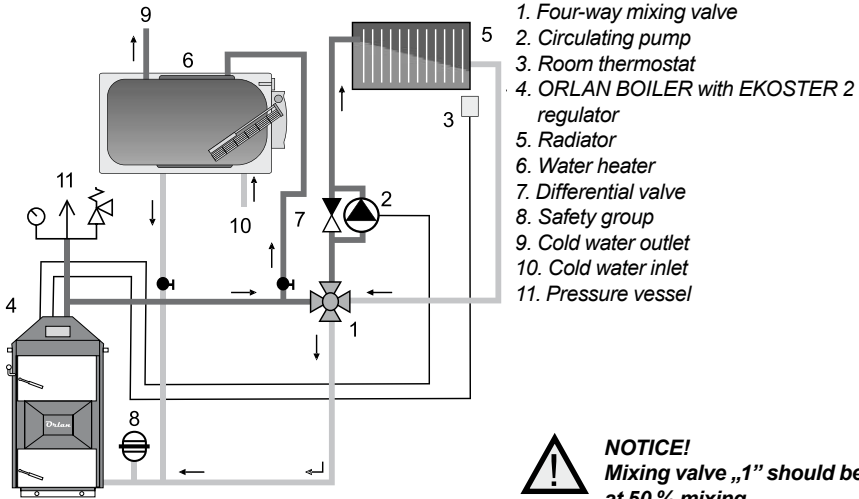

NOTICE!
Mixing valve „1” should be set at 50 % mixing.

Pic.5 An exemplary scheme of the Orlan boiler, four-way mixing valve and water heater connecting.

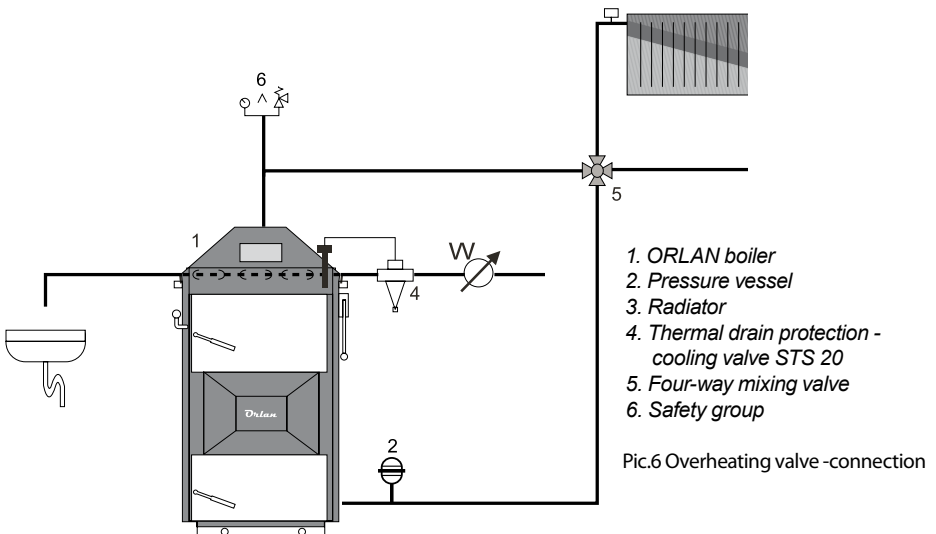

Pic.6 Overheating valve -connection

6.2. Wood and gasification

It is important that wood gasification boilers worked in specific conditions. Boiler's temperature accounts for above 80 °C. At lower temperatures gasification doesn't proceed in a correct way and what follows - wood intake is relatively higher. Wood drying in a loading chamber is an essential stage in gasification process - wood doesn't have adequate temperature at lower temperatures and all of the process is inadequate. Main warmth source in Orland boilers is gas flame arising during gasification, if main conditions according correct burning process aren't taken, then both quality and quantity of released gas won't be sufficient.

Very important are: quality, humidity and kind of burned wood. Hard wood is the best - (beech, oak, hornbeam etc.) at 15 up to 25 % humidity. Using different kinds of wood, such as pine, spruce etc. is possible but there will be more burning waste at the sides and it will be necessary to load the chamber more often. Hygrometer is for humidity measuring - it helps to select wood at best quality (there is a guideline diagram of wood's humidity on the next page).

Right quality of wood warrants proper boiler's working. Using the fuel at different parameters doesn't guarantee correct boiler's operating.

Tab. 4 Wood density diagram

wood type	density of just cut wood [kg/m ³]	density of dry wood [kg/m ³]
coniferous tree		
pine	700	480
larch	760	600
spruce	740	430
fir	1000	450
deciduous tree		
oak	1080	710
elm	950	680
ash	920	750
beech	990	730
hornbeam	1080	830
alder	690	530
birch	650	650
maple	870	660
lime	730	530

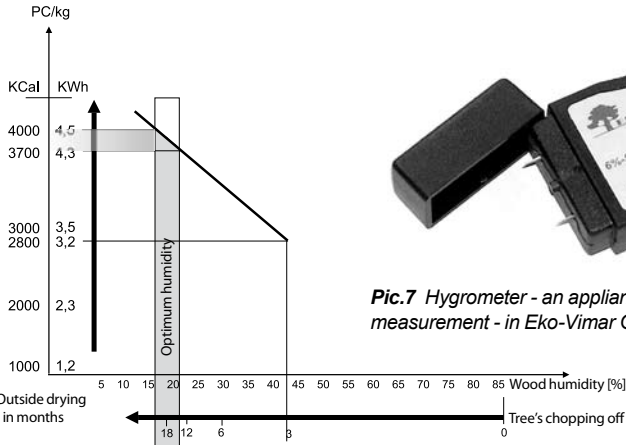

Pic.7 Hygrometer - an appliance for humidity measurement - in Eko-Vimar Orlański's offer.

Pic.8 Wood humidity chart.

6.3. Accumulation

The best results in heating gives boiler's connecting with an accumulation tank. Such installation causes less wood using - even up to 40 %. Gasification process (if it runs in optimum way) generates large gas quantity, heating system however is characteristic for large fluctuation amplitude in warmth requirement scope. Gasification process is set only in certain way, heating system fluctuation change more often, room might get overheated or some extra gas can get through the chimney. Accumulation system allows for gas storing in an accumulation tank. Heating system is contributed by accumulation tanks for about 48 h (depending on tanks' capacity and thermal conditions - at about 50 l of water for 1 kW of power). If the boiler cooperates with accumulation tank, its long lasting is lengthened.

1. Boiler with Ekoster 2 regulator
2. Thermoregulator
3. Accumulation tank
4. Electrical heater
5. Three-way mixing valve
6. Circulating pump
7. Programmable room thermostat
8. Heating system exit
9. Pressure vessel
10. Mixing valve of DHW
11. Coil
12. Solar panel
13. Heating medium pump
14. Safety group

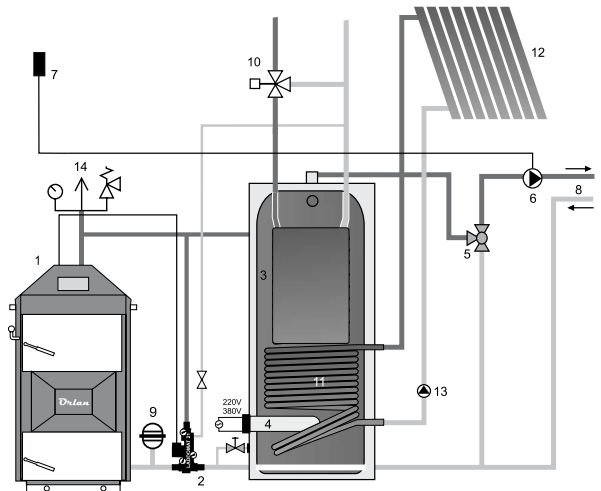

Pic.9 An exemplary scheme of connecting an accumulation system with one accumulation tank (with build in DHW container, coil and a solar).

6.4. Starting

Before first boiler's use there should be checked: leakproof of the threaded joints (whether there isn't any leak) installation water level, the parameters of boiler's operating are to be set as well.

6.5. Burning up

The steps to be taken to burn up in the boiler:

1. Switch off the power.
2. Push the chimney flap (gas pass opened).
3. Place splinters and some bigger wood pieces to the boiler upper chamber.
4. Burn the paper and close the upper door.
5. Open the bottom door as to provide natural draught.
6. Wait for about 15÷20 min. for better wood burning.
7. Put that much of wood to get the right quantity of embers which will cover boiler's bottom (ca. 10 cm) (chopping of the wood in about 5 cm pieces at the first stage of burning up accelerates embers' producing).
8. Wait for 15÷20 minutes for the ember layer occurring.
9. Fill up the whole combustion chamber.
10. Close the upper and bottom door hermetically.
11. Pull the chimney flap and switch on the fan.
12. When the boiler reaches 60 °C fan will start working automatically.



WARNING!

It is forbidden to switch on the fan when the upper door is opened.



IMPORTANT!

It is important to pay an attention on both depth of gasification chamber and thickness of the upper door while chamber's loading. If wood's sizes aren't adequate to the elements mentioned above it may be difficult to close boiler's door or load the chamber with wood. You must not close the door by force - it may cause door's damage.



IMPORTANT!

Wood storing for about a year ensures its right humidity (admissible humidity - 25 % - look at TECHNICAL DATA section). Advisable humidity level (15 %) is to be obtained after 2 years wood storing (look at the diagram no 7).

6.6. Fuel loading

If the boiler is chosen adequate to the place to be warmed up there is one loading for 8÷12 hours needed. It is advisable however to control the boiler every 5÷7 hours. To control wood quantity you should:

1. Switch off the boiler with the main switch.
2. Open the chimney flap.
3. Open the upper door and load the chamber if it's necessary.
4. Close the door, chimney flap and switch on the boiler.

It is important not to let the fuel to get between combustion chamber and chimney flap as it would obstruct chimney flap's closing.

When loading (it is recommended to burn out the fuel up to embers) there is a need of taking down ash deposited on the loading chamber's sidewall.

**NOTICE!**

Lack of fuel is signalled with a red indicator STOP 

6.7. Boiler's putting out

Boiler puts out in two ways: after turning off button pressing or after all of the wood burning out.

6.8. Optimum boiler's temperature assuring

Right boiler's temperature maintaining during its exploitation is very important. To assure correct gasification process water temperature should be about 75 °C.

In the time of a large warmth need returning water's temperature may lower. If returning water is about 20 °C lower than contributing one, there is a risk of gasification chamber cooling and it can result in boiler's efficiency decreasing (gasification process may be limited). As a result - pitch can deposit at the boiler's sidewalls. To avoid such situation there should be „little water circulation” build in the boiler. To build it in three or four way mixing valve should be installed at the boiler's outlet. It mixes hot water with returning one. By correct hot and cold water setting, returning water is warm enough as not to let for temperature's rapid decreasing in the gasification chamber - then gasification process correctly. Temperature's difference 15÷20 °C doesn't cause large charge of material of which boiler is made of and as a consequence it lengthen boiler's exploitation time.

6.9. Power failure and pump's breakdown

There is a risk of power deficiency or pump's breaking down during boiler's exploitation. If it happens in winter time, fuel filling should be stopped. Boiler's working with a chimney flap opened is unacceptable. Boiler's working with full chimney draught may cause its uncontrollable working and as a consequence it can cause water's boiling and boiler's overheating. In case of extorted circulation installation, current flow's breakdown causes fan's and pump's turning off. The case of wrong warmth passing on from the boiler to the heaters may cause water's overheating. It's advisable to install an additional container such as water heater to avoid water's overheating. Its role is to assure min power taking from the boiler ex 5 kW for the 25 kW boiler. It protects the boiler against its overheating.

**NOTICE!**

To protect the boiler and its electric equipment against network's voltage exceeds it's advisable to use some constant - voltage regulator (e.g. computer strip).

7. Conservation

7.1. Boiler's conservation

Except for the elements described in „BOILER'S EXPLOITATION“ preserving it is important that the boiler was protected during its stagnation (summer time, householders' absence). Boiler's interior, hest, exchanger, chimney flap should be cleaned through - it's advisable to burn some dry softwood (ex. spruce) in the boiler before its stopping over - it will burn out the waste occurring during boiler's exploitation. After boiler's cleaning it should be left opened for aerating - in the way you will avoid humidity condensation in the boiler.



NOTICE!

It is advisable to control the boiler annually in order to prepare it well for the next heating season.

7.2. Fan's conservation

Fan is an essential boiler's part. Keeping it in clean have a bearing on its longlasting. It's advisable to disassembly fan's body from time to time and to clean it through (the waste deposited). Fan's blades can be cleaned with a soft bristle brush.



NOTICE!

Boiler's working with the bottom door opened is unacceptable because in such a case the fan can get overheated.

7.3. Boiler's cleaning

The ash arising while burning process go down to the ash pit via the nozzle. The ash pit should be cleaned every 3-5 days. Gasification chamber should be cleaned out between next burning up. Ash is to be cleaned out via the nozzle - watch out as not to damage the boiler's bottom. For cleaning there should be used original appliances (enclosed as standard equipment). During gasification process pitch occurs. Its quantity depends on wood, its humidity and contributing and returning water's temperature. It's advisable to clean out gasification chamber with a scraper (once a month). Carbon deposit subsiding at the pipes causes diminish of the exchanger's section and in the same time decreasing of the heat exchange. As a result it effects the thrust decreasing and obstructs in heat transmitting. In accordance to this the exchanger's pipes should be cleaned out every two weeks to assure their permeability. (In SUPER boiler they should be cleaned after every fuel loading.)

Four steps to clean out the exchanger (except for the SUPER type)

1. Take off the boiler back upper casing.
2. Turn on the nuts with M13 - M17 spanners (depending on boiler type).



Important!

Before nuts turning on and turning off the thread should be preserved with a special anti corrosion agent; do not turn on nuts with exertion.

3. Each of the pipes in the exchanger should be cleaned with a cleaning shield. They should be cleaned precisely in the whole length - it is important to avoid soot's gathering at the bottom part of the exchanger's pipe and its blocking. Clean the soot deposited at the back part of the chamber.



Important!

As to avoid the soot sediment in lower part of an exchanger it is necessary to sweep out the soot from the back part of the boiler chamber.

The Eko-Vimar Orlański advises using SADPAL - a catalyst for wood tar burning. It is to burn up the wood tar all over the boiler, beginning with a burner, combustion chamber and a chimney. All details according to the SADPAL use are written on a packaging. The product is available in Eko-Vimar Orlański offer.

7.4. Leakproof securing

Leakproof of the boiler is very important especially leakproof of the door, the exchanger and chimney flap. Leakproof causes the fumes' coming out of the boiler and most of all it can cause uncontrolled burning which may cause boiler's overheating. To ensure the exchanger's door leakproof the insulation rope should be sealed with a graphite oil or some other machine oil at least once a week. It softens the rope and causes its tight adjoining to the boiler.

After some time of boiler's operating (1 season for example) the door rope could get flatted. To assure right rope's adjoining to the boiler's door, door setting regulation is provided (regulation on the hinge).

Hinge door setting:

- a) take the door off
- b) loosen the cap
- c) turn the hinge 360°
- d) turn a tap tight to block hinge's regulating screw.



NOTICE!
Upper and down hinge should be regulated in the same time.

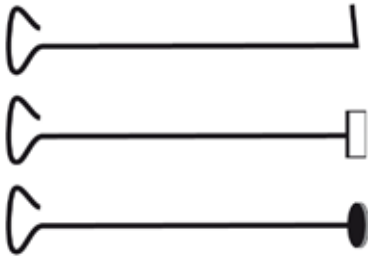
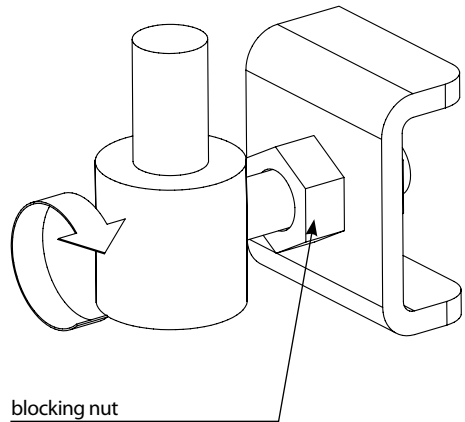

- Only in STANDARD version

Pic10. *Cleaning elements.*



NOTICE!
Chimney flue's leakproof should be controlled and if such a need occurs - it should be cleaned out. All of the threaded elements before their unscrewing should be lubricated with grease. Door and hinges should be lubricated temporarily as well.

7.5. After-heating season maintenance activities

It is necessary to prepare boiler for upcoming heating season in order to assure trouble-free boiler usage.

It is recommended to commission boiler inspection to qualified serviceman of boiler distributor. This will guarantee professional and skilled boiler preparation based on long-term experience of boiler producer.

ACTIVITY:

- thoroughly clean upper and bottom chamber from remaining ashes
- clean upper chamber's all sides from tar with boiler tools as deposited tar creates layer of insulation that decreases boiler efficiency
- remove fan cover and clean fan blades with brush or vacuum cleaner
- check and clean if necessary primary air if there's a free flow of air by turning on the fan on cleaned boiler (air goes to upper chamber with two channels on the front left and right side of upper chamber; air is blown with fan). Tar may deposit in these channels that obstruct proper amount of air supplied to upper chamber.
- check and clean if necessary secondary air if there's a free flow of air by turning on the fan on cleaned boiler (air goes to nozzle via 2 pipes and is blown through holes in nozzle; air is blown with fan) Tar or ash may deposit in these holes that obstruct proper amount of air supplied to nozzle.
- check cleanliness of heat exchanger's pipes
- clean connecting flue pipe between boiler flue and chimney. Clean chimney as correct chimney draft is vital for boiler running
- grease all threaded parts (hinges, door handle)
- grease door ropes (this should be done every 3 weeks as flexible ropes protect boiler from smoking outside to boiler room)
- prepare wood for upcoming heating season – use only wood with moisture content below 25%. Check moisture content with moisture meter on split wood log into halves. Wood log should have length the same as chamber depth (ex. Orlan 25 kW – 50 cm)

ATTENTION!!!

IT IS CRUCIAL FOR PROPER BOILER RUNNING TO HAVE PRIMARY AIR CHANNELS AND SECONDARY AIR PIPES CLEANED AND FREE OF ANY ELEMENTS THAT MAY OBSTRUCT FLOW OF NECESSARY AIR TO UPPER CHAMBER AND NOZZLE. OBSTRUCTED FLOW OR NOT ENOUGH OF IT MAY LEAD TO UNPROPER BOILER BURNING – BOILER WOULD NOT BE ABLE TO REACH RECOMMENDED SET TEMP. OF 80-90 DEGREES WHICH IS NECESSARY FOR GASIFICATION BOILER TO FULLY UTILIZE ENERGY IN WOOD. AT LOW TEMP. AND WITH LONG RUNNING ON LOW TEMP. BOILER CREATES EXTENSIVELY TAR THAT CLOGS PRIMARY AND SECONDARY AIR CHANNELS. BOILER WITH NOT ENOUGH AMOUNT OF AIR SMOKES EXTENSIVELY CREATING ACIDS CONTAINED IN WOOD THAT CAN LEAD TO INNER BOILER PLATE THINNING.

ATTENTION!!!

INNER BOILER PLATE THINNING MAY ALSO BE RESULT OF BURNING WOOD WITH MOISTURE CONTENT ABOVE 25%.

8. Faults caused by boiler's wrong exploitation and their removing

Problem	Cause	Remedy suggested
boiler doesn't reach the temperature needed	faulty burning up	check „Burning up“
	to moist wood	humidity control - use wood at right parameters
	primary air conduit choked	call service - facility out of the warranty
	secondary air conduit choked	call service - facility out of the warranty
	smoke tube of heat exchanger choked	clean with a cleaning shield or call service- facility out of the warranty
	wrong regulation of the air and wood gas	call service - facility out of the warranty
	nozzle damaged	replacement - out of the warranty
	fan's gasket damaged	replacement - out of the warranty
	fan damaged	replacement - out of the warranty
smoke out of the cleaning cover	leak on a seal rope	door regulation or call service – out of the warranty
	seal rope worn	rope's replacement - out of the warranty
	cover warped - overheating	cover's replacing or call service- out of the warranty
smoke coming out while loading (little smoke is acceptable)	intensive - Heavy wind blows the fumes into the chimney	consider the montage of chimney flue succouring elements, for instant the „Rotowent“ ones
	wrong chimney parameters	consult a chimney sweep, the need of new chimney flue building
smoke out of the boiler's door	leak on a seal rope	door regulation (according to the 7.4. description)
	seal rope worn	rope's replacement or call service - out of the warranty
	door damaged	door's replacement
regulator doesn't work	power shortage	check the installation's protection
	fuse damaged	fuse's replacement
	live wire conduit damaged	connection and wire's inspection
	temperature sensor damaged	call service
	regulator damaged	call service
fan out of order	thermal protection worked	check „boiler's overheating“ description
	no power in regulator	check „power shortage in regulator“
	fan damaged	call service - fan's replacement
	regulator damaged	call service
	fan blocked	inspect and clean the fan

Problem	Cause	Remedy suggested
fan's loud working	bearings damaged	call service - fan's replacement
	condenser damaged	call service - condenser's replacement
	fan montaging clips loosened	checking, turn the clips tight
	fan's blades unclean	checking, cleaning
	unneeded unit in fan's cover	checking, cleaning
poor fan's working	fan's blades unclean	checking, cleaning
	fan's cover with a pitch on the fan's cover	call Service- out of the warranty
detonation in the boiler	wrong burning up	look „Burning up“
	chimney draught to low (below 10 Pa)	chimney rebuilding. Use WKO exhaust fan
	chimney draught to intensive (over 20 Pa)	use exhaust regulator
	to tiny and to dry wood (humidity over 15 %)	mix with larger humidity fuel as to increase humidity level (in about 15-25 %)
	furnace flue of the exchanger uncleaned	clean the exchanger or call service- out of the warranty

9. Allowance for Orlan SUPER boilers

Wood boilers in version SUPER are equipped with a cooling coil (preserving against overheating) and mechanical cleaning devices.

9.1. Cooling coil

In connection with thermostatic cooling valve cooling coil's function is the boiler's overheating protection. We connect a cooling coil with thermostatic valve to the cold water installation (ex. STS 20 Watts). Cooling coil outlet is to be directed into plughole installation.

9.2. Cleaning devices mechanism

Mechanical cleaning devices allow for heat exchangers keeping in clean. Cleaning elements are made as economizers placed in a heating pipe. They are moved with a handle placed out of a boiler.



NOTICE!
As not to let cleaning devices and furnace flue to get dirty with burning remnants it is important to use cleaning

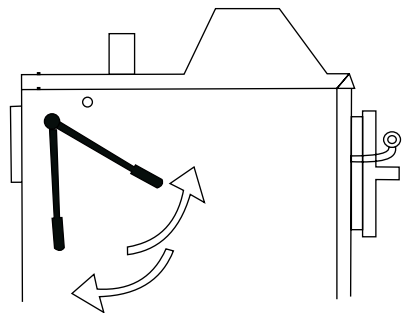

Warranty notice

Small cracks on the surface of the insulation board of ashes on the surface firing channel (profile "U") are normal and does not affect operation and the lifetime of the parts. Combustion channel is consumable and the lifetime of these is influenced by the quality and duration of combustion operation (humidity of the wood must be below 20%)

. The boiler room, If it's humid constantly firebrick absorbs the vapor which when boiler fired expands and evaporate and cracks the firebrick.

10. Utilizing

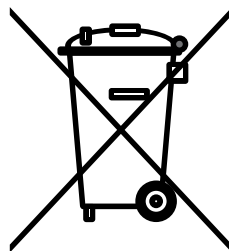

The appliance is approved according to the European Directive 2002/96/EC in the matter of electrical and electronic devices' waste (WEEE). Ensuring right its scrapping you help to protect the environment.

Wrong utilization of the appliance may cause negative influence on the environment. To prevent it - make sure that you utilize the boiler in a proper way.

The symbol placed either on the device or in the documents enclosed means that the product isn't classified as a household waste.

The appliance should be taken to an authorized collection point in the matter of electric and electronic components recycling.

The wood boiler should be scrapped according to local regulations according waste utilization.

More informations according utilization, scrapping and recycling you can get in the local city hall, in civic waste utilization company or in the place of he machine buying.



CRANP-KOVO s.r.o.

790 70 Javorník, Miru 371

CZECH REPUBLIC

T +420 584 492 808

F +420 584 492 888

E sekretariat@orlanski.cz

www.orlanski.cz

orlański



natural warmth of the house

